

# Kwik-Tie®



# Waterstop

 **VINYLEX**  
CORPORATION

P.O. Box 7187 • Knoxville, TN 37921-0887 • Phone 800-624-4435 or (865) 690-2211  
Fax (865) 691-6273 • Email: [constr@vinylex.com](mailto:constr@vinylex.com)

## Why Choose Vinylex Products

Vinylex Waterstop prevents water movement through concrete joints in a number of applications including reservoirs, locks, canals, dams, sewage and water treatment plants, bridges, stadiums, basements, floor slabs, parking garages, and many other structures. Vinylex Corporation has established a reputation for producing only the finest extruded plastic products. Only virgin resins are used in Vinylex Waterstop. . . never reprocessed or reclaimed materials. The elastic and abrasion resistant qualities of Vinylex Waterstop, together with high resistance to oxygen, ozone, alkalis or waterborne chemicals allows its use in any subterranean or surface construction.



## The Line of Vinylex Products

### Waterstops

When construction involves cast-in-place concrete members under conditions where the joints will be subject to water seepage or hydrostatic pressure, Vinylex Waterstop should be installed. In all below grade construction and in any surface structure where it is necessary or desirable to contain or exclude moisture or water under pressure, Vinylex Waterstop provides a simple, effective and positive seal.

### Chamfer Strips

Vinylex chamfer strips are employed in outside corners of poured concrete members to provide a smooth level finish that reduces plastering and pummacing time.

### Radius Formers

On columns, piers, panels, beams or any outside corner poured concrete, Vinylex Radius formers provide a clean, smooth, uninterrupted round finish edge.

### Drip Strips

Vinylex Drip Strip provides a smooth uniform drip groove on the underside of roof overhangs.

### Control Joints

Vinylex Control Joints are recommended in long walls and at joints involving pilasters, columns, etc., to allow expansion and contraction without cracking.

### Removable Cap Strips

The secret to quick & clean expansion joints! You can get rid of the costly handwork usually involved in forming expansion joints. The Vinylex Removable Cap Strip does the work for you, cutting down on time & costs. Made of high-impact polystyrene, it is produced in standard 10 ft. lengths, and four standard widths.



## The Selection of Vinylex Products

### Non-working joints

In construction or cold joints where little or no movement is expected we recommend Flat Ribbed or Dumbbell

### Working Joints

In expansion joints where movement is expected we recommend Ribbed with Center bulb or Dumbbell with Center bulb.

### Excessive Movement

We recommend Tear Web Waterstops which will allow movement up to 2" without stress on the material.

### Available Sizes

Flat Ribbed	4" - 12"
Ribbed with Bulb	4" - 12"
Dumbbell	4" - 12"
Dumbbell with Bulb	6" - 9"
Tear Web	6" - 9"

## Product Selector Guide

SELECTION CRITERIA	WATERSTOPS						
	FLAT RIBBED	CENTER BULB RIBBED	SPLIT RIBBED	TEAR WEB	DUMBELL	BASE SEALS	SPECIAL SHAPES
KEY • Recommended							
JOINT TYPE							
Construction Joint	•	•	•	•	•	•	•
Expansion Joint		•	•	•			
Installation: Cast-in-place	•	•	•	•	•	•	•
Inserted	•	•	•	•	•		
Width: 4" - 12"	•	•	•				
Length: < 50'				•			
50'	•	•	•	•	•	•	•
100'	•	•	•		•	•	•



Our capabilities enable Vinylex to furnish factory-made splices to your job site. This eliminates all field splices except the butt welding of straight lengths. For pricing or information, contact Vinylex.

# WATERSTOPS

03250/VIN  
BuyLine 0622

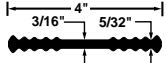
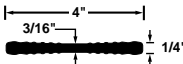
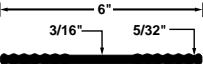
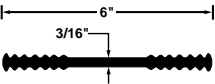
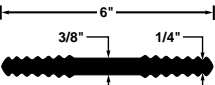
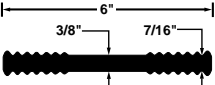
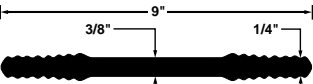

## Flat Ribbed

Vynlex flat ribbed waterstops are employed in construction joints where movement between members **is not** anticipated. They are generally used below grade in footings, walls, slabs, or for breaks in concrete due to limitations in working methods.

Application Type	HEAD OF WATER - FT.	WT. LBS. 100 LIN. FT.	CATALOG NUMBER
Vynlex flat ribbed water stops are employed in construction joints where movement between members is not anticipated. They are generally used in footings, walls, seals, or for breaks in concrete due to limitations in working methods.	75	40	R4-316T 
	75	55	R4-316 
	100	73	R6-316T 
	100	82	R6-316' 
	125	128	R6-38T 
Vynlex flat ribbed water stops are employed in construction joints where movement between members is not anticipated. They are generally used below grade in footings, walls, seals, or for breaks in concrete due to limitations in working methods.	125	151	R6-38 
	150	183	R9-38T 
	150	214	R9-38* 

## Ribbed with Center Bulb

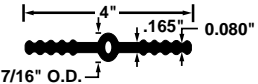
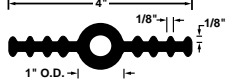
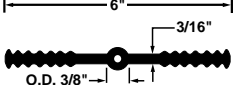
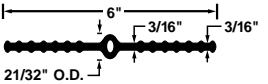
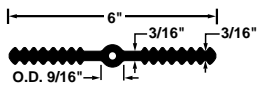
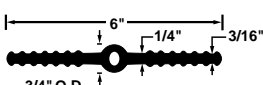
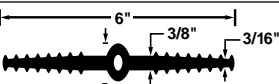
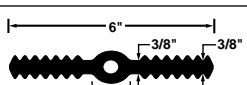
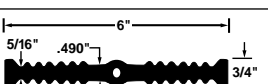
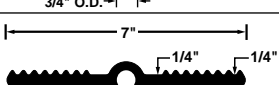
Vynlex ribbed center waterstops are employed in expansion joints where movement between members **is** anticipated. They are generally used above grade but in fact are a universal design and can be used in any type of joint above or below grade.

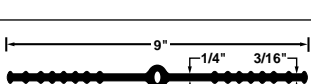
Application Type	HEAD OF WATER - FT.	WT. LBS. 100 LIN. FT.	CATALOG NUMBER
Water tanks, swimming pools, substructures and buildings.	65	40	RB4-316 
Water tanks, swimming pools, substructures and buildings.	65	78	RB4-316H** 
Construction joints with higher heads of water than 4" water stops.	100	73	RB6-316 
Filtration plants and heavy duty waste water treatment plants.	100	78	RB6-316H 
New York State Type A.	100	82	RB6-316HR N.Y. Type A 
Can be used above and below grade	100	93	RB6-14 
Can be used above and below grade	125	114	RB6-38 
Extra heavy to resist displacement during pour. Also for heavier heads of water than RB6-38.	125	160	RB6-38H 
	150	166	RB6-12 
New York State Type B.	110	128	RB7-14HR N.Y. Type B 
For use in less expansion joints.	150	112	RB9-316 
More resistance to displacement during pour than RB9-316	150	143	RB9-14 

\*Conforms to James M. Montgomery Specifications

\*\*Conforms to CH2 M. Hill Specifications

## Ribbed with Center Bulb

Vinylex ribbed center waterstops are employed in expansion joints where movement between members **is** anticipated. They are generally used above grade but in fact are a universal design and can be used in any type of joint above or below grade.

Application Type	HEAD OF WATER - FT.	WT. LBS. 100 LIN. FT.	CATALOG NUMBER
More resistant than RB9-14 to displacement during pour.	150	155	<b>RB9-14HR</b> 
For use in dams, reservoirs, locks and sewage plants with large heads of water.	150	186	<b>RB9-38*</b> 
Same as RB9-38 but will accommodate extra movement.	150	234	<b>RB9-38H**</b> 
To accommodate extra movement in both expansion and shear	150	220	<b>RLB9-38</b> 
Application in major structures, powerhouses, and dams with extra high heads of water	200	270	<b>RB9-12</b> 
For use when extra movement in both expansion and shear is expected.	250	381	<b>RB12-12</b> 

## Split Ribbed

Vinylex split ribbed waterstops are used in either construction or expansion joints where elimination of split form work is feasible. The split leg of the waterstop is spread open and nailed to the bulk head. When the form work is removed following completion of first pour, the split leg is joined together and the second pour completed.

Application Type	HEAD OF WATER - FT.	WT. LBS. 100 LIN. FT.	CATALOG NUMBER
Vinylex split ribbed water stops are used in either construction or expansion joints where elimination of split formwork is feasible. The split leg of the waterstop is spread open, and secured to the bulkhead. When the formwork is removed following completion of the first pour, the split leg is then joined together, secured and the second pour completed.	65	51	<b>RSB4-316</b> 
	100	79	<b>RSB6-316</b> 
	125	138	<b>RSB6-38</b> 
	125	186	<b>RSB6-12</b> 
	100	118	<b>RSB9-316</b> 

HEAD OF WATER - FT.	WT. LBS. 100 LIN. FT.	CATALOG NUMBER
150	214	<b>RSB9-38</b> 
250	382	<b>RSB12-12</b> 

## Dumbbell

Vinylex dumbbell waterstops are used in construction joints where movement between members **is not** anticipated. They are usually employed below grade and in horizontal applications. Dumbbell waterstops with a centerbulb are suitable for use where movement between members **is** anticipated.

Application Type	HEAD OF WATER - FT.	WT. LBS. 100 LIN. FT.	CATALOG NUMBER
For construction joints to 1 1/2" in width with.	100	118	<b>DB6-14</b> 
	150	312	<b>DB9-38</b> 
To be used in large pours with expected movements, flood walls, large treatment plants.	150	350	<b>DLB9-38</b> 
For expansion joints of 1" or less in width.	150		<b>DSB9-38</b> 
Economical shape for below grade construction joints.	65	48	<b>D4-316</b> 
Footings, walls and slabs. For expansion joints below grade where little or no movement is expected.	100	74	<b>D6-316</b> 
	100	98	<b>D6-14</b> 
Most popular shape in dumbbell waterstops.	125	151	<b>D6-38</b> 
For expansion joints of 1" or less in width.	150	217	<b>D9-38</b> 
	150	250	<b>D9-38LB</b> 

\*Conforms to James M. Montgomery Specifications

\*\*Conforms to CH2 M. Hill Specifications

## Base Seals

Although Vinylex manufactures more than sixty stock waterstop profiles, engineering and design sometimes require a different configuration. Shown here are a number of cross-sections which have been designed to meet some of these special applications. Each has been thoroughly tested on the job.

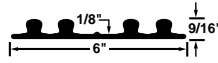
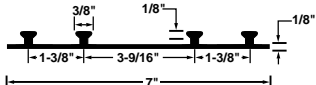
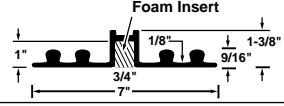
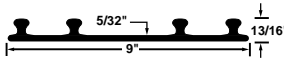
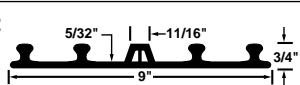
Application Type	HEAD OF WATER - FT.	WT. LBS. 100 LIN. FT.	CATALOG NUMBER
Economical and efficient below grade water seals. Quickly and easily installed. No special forms required. Laid in position on subgrade and centered on joint. Ideal for garden apartments and light construction. Applications may also be installed on vertical joints below grade when hydro static head < 15 head ft. or less of water is encountered.	87		<b>BS6-18</b> N.Y. Type D 
	64		<b>BS7-18</b> 
	122		<b>BSE7-18</b> N.Y. Type E Foam Insert 
	134		<b>BS9-532</b> 
	144		<b>BSE9-532</b> 

## Special Shapes

In rare instances, a specially designed profile may be required. When a need of this nature arises, consult your Vinylex Distributor.

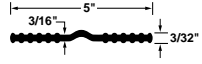
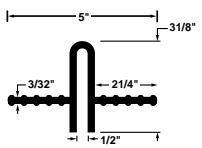
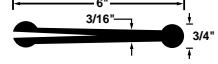
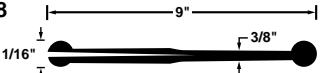
Application Type	HEAD OF WATER - FT.	WT. LBS. 100 LIN. FT.	CATALOG NUMBER
Ribbed type waterstop used in special applications to eliminate splitting of form. Can be used in expansion and construction joints.	85	56	<b>V5-316</b> 
Bridge deck joint to meet Cal. State Hwy. Dept. specifications. Now used throughout the country. "Open End" bulb provides maximum expansion capabilities. Nailing flanges permit easier installation.		112	<b>W1-2</b> 
Eliminates split formwork where center bulb is not required.	125	160	<b>DS6-38</b> 
	125	214	<b>DS9-38</b> 

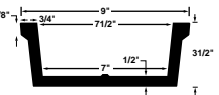
Application Type	HEAD OF WATER - FT.	WT. LBS. 100 LIN. FT.	CATALOG NUMBER
Highway seal prevents water escape at joints on bridges, over passes and similar		170	<b>L85-14</b> Ny.Y. Type CA State of Mass. 
Originally designed for flood control projects. Used at base of gravity-type floodwalls		450	<b>U9-12</b> 

## Tear Web

Used when abnormal or unusual joint opening is anticipated. It is easily remembered by our designation "TWB" (Tear-Web Bulb).

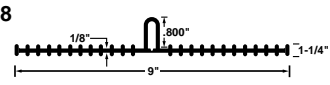
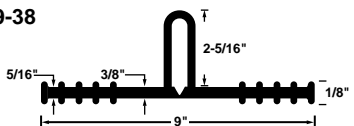
Application Type	HEAD OF WATER - FT.	WT. LBS. 100 LIN. FT.	CATALOG NUMBER
For use in vertical and horizontal expansion joints, construction joints, and control joints where a slight differential movement between adjacent members or expansion of the joint is anticipated, water and sewage plants, walls, bridges, stadiums, floor slabs, and parking garages.	100	82	<b>TWB 6-18</b> 
	150	130	<b>TWB 9-18</b> 
	200	365	<b>TWB 9-38</b> 

## Installing Vinylex Waterstops

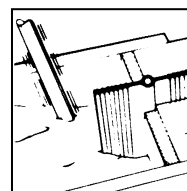

### Ribbed Center Bulb

Systematically and thoroughly vibrate concrete around water stop to avoid honey-combing and voids to insure complete contact between waterstop and concrete.

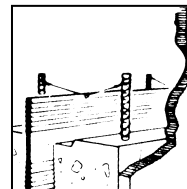

### Flat Ribbed

Hold Waterstop securely in place to prevent misalignment during concreting operations.

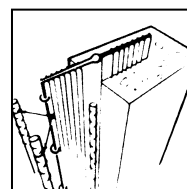

### Split Ribbed

Hold split legs together for second pour by using hog rings every foot between last rib and the end of the waterstop.

## DOs and DON'Ts For Installation



**DO NOT**  
Drive nails through center of waterstop when forming.

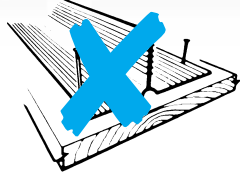

**DO NOT**  
Secure waterstop except between the last rib and the end of the waterstop when tying to the reinforcing rods to hold in place for the pour.



**DO NOT**  
Embed bulb in concrete. It must be positioned in center of joint to insure freedom of movement.

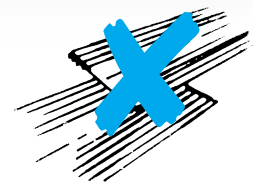

**DO NOT**  
Lap sections of waterstop. All joints should be spliced with a heat sealing method. See instruction sheet #6035.

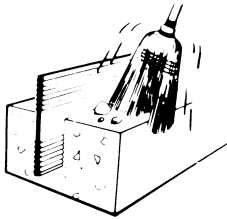

**DO**  
Sweep all horizontal joints prior to pour to insure that foreign material does not interfere with direct contact between waterstop and concrete.

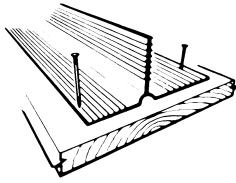

**DO**  
Nail split legs to bulkhead between the last rib and the end of the waterstop.

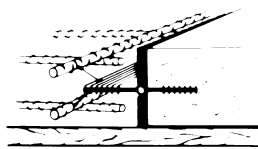

**DO**  
Hold waterstop securely in place to prevent misalignment during concreting operations.

## Splicing

The WS-1 splicing iron is recommended for splicing large centerbulb waterstops. WS-2 is suitable for other splices. Other sizes and options are available.

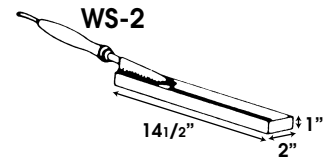
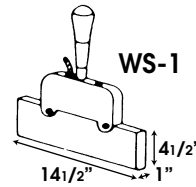

## CONTROL JOINTS AND CONCRETE FORMERS

### Control Joints

Vinylex Control Joints are designed for use in solid or cavity masonry wall construction. Control joints allow for expansion and contraction.

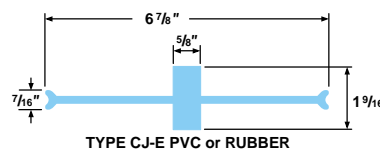
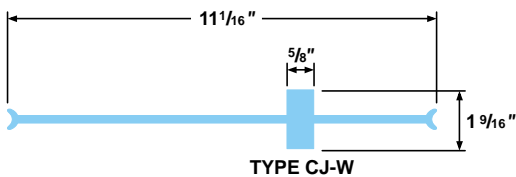
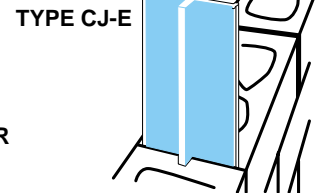
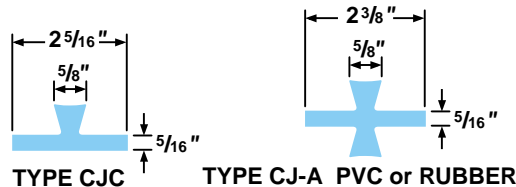

### Radius Former

Vinylex Radius Formers are made from a specially formulated, plastic material that provides a smooth, uninterrupted, rounded radius corner. The material strips cleanly from finished concrete and is easily removed from forms for reuse.

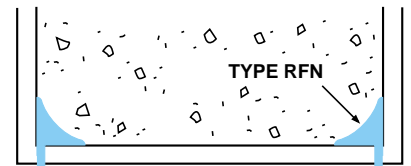
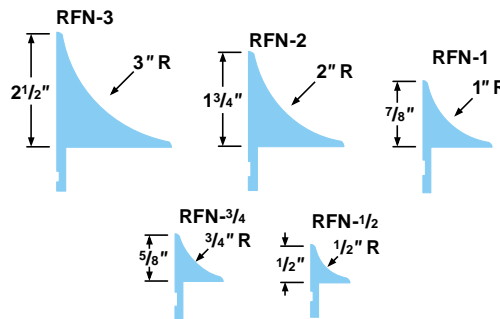

### Drip Strips

Vinylex Drip Strip provides a smooth uniform drip groove on the underside of roof overhangs and porches. The material is nailed to the form and is easily removed from the concrete. It also can be reused several times.

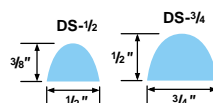

## Chamfer Strips

Vynlex Chamfer Strips provide a smooth, uninterrupted beveled edge to piers, beams and all outside corners of poured concrete. They are easily applied, equipped with or without nailing flange to facilitate installation, and reusable for maximum economy.

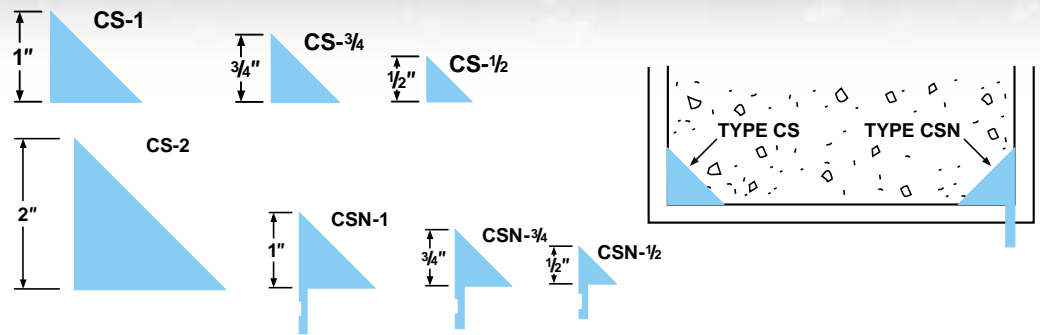

## Removable Cap Strips

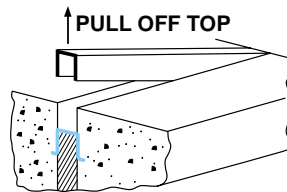
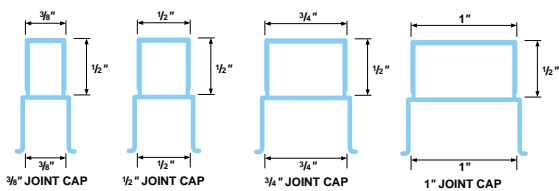

## Elephant Trunks

Vynlex Elephant Trunk makes difficult wall pours easy. Made from durable polyvinyl chloride, it is strong, lightweight, and ribbed for greater strength. Vynlex Elephant Trunk is available in 6, 8, and 12 inch diameters. It is easily affixed to concrete hoppers by the use of band steel and hand tools.

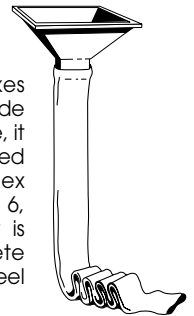

## Stresscap Control Joint Former

STRESSCAP is the fast, economical way to form a control joint for the purpose of creating a vertical plane of weakness in the slab. The formation of the control joint takes only a few minutes during the normal finishing process. As the concrete cures, shrinkage stress-cracking will occur at this vertical weakened plane created by STRESSCAP rather than at random locations in the slab. This STRESSCAP created control joint is faster, easier and far less expensive than saw cutting or checkerboarding. STRESSCAP is available in standard lengths of 10 feet and standard heights of 1" and 1 1/2". The depth of the control joint should be 1/4 the thickness of the slab.

Dimensions given in this brochure represent typical values from our manufacturing processes. Standard tolerances apply.

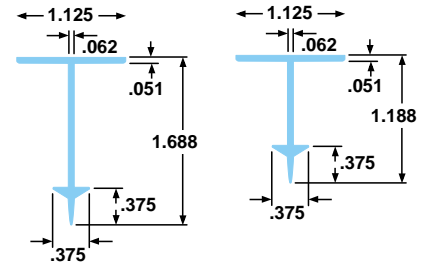

## Technical Properties

PROPERTY	TEST METHOD	TYPICAL RESULTS
<b>TENSILE STRENGTH</b>		
Finished Waterstop (Avg.)	ASTM D-638	2100
<b>ULTIMATE ELONGATION</b>		
Finished Waterstop	ASTM D-412	350%
Hardness-Shore A/10	ASTM D 2240	82 ± 3
Stiffness in Flexure	ASTM D-747	1200 psi
Tear Resistance	ASTM D-624	314 lb./in.
Modulus of Elasticity	ASTM D-638	900 psi
Low Temperature Brittleness @-35°F	ASTM D-746	Passed
Cold Bend, 1/4" Mandrel @-30°F	TVA PF1026	Passed
Low Temperature Flexibility @-30°F	TVA PF1026	Passed
Low Temperature Impact @-30°F	TVA PF1026	Passed
<b>WATER ABSORPTION</b>		
24 Hour	ASTM 570	0.051%
48 Hours	ASTM 570	0.077%
Accelerated Extraction	CRD C-572	Passed
Effect of Alkali	CRD C-572	Passed

## Short Form Specifications

All waterstops for expansion and construction joints shall be Vynlex Waterstop as manufactured by Vynlex Corporation, Knoxville, Tennessee. The waterstops shall be manufactured from virgin polyvinyl chloride plastic compound, and shall not contain any scrap or reclaimed material. The properties of the polyvinyl chloride compound used shall conform to U.S. Army Corps of Engineers waterstop specifications.

It is not the intent of these specifications to eliminate competitive products that positively equal Vynlex. Qualified substitutions will be permitted if properly documented and submitted to the Architect/Engineer. No substitutions will be permitted unless same have the written approval of the Architect/Engineer, at least 7 days prior to the date and hour set for filing the bids.

All styles and sizes of Vynlex Waterstop are available in standard rolls of 50' or 100' lengths, depending on profile size.

## Codes

All Vynlex finished Waterstops are designed to meet or exceed requirements of:

- Corps of Engineers CRD C-572
- T.V.A. Spec No PF-1026
- Bureau of Reclamation Soil Conservation Service
- Various State Highway and Departments of Public Works
- Ontario Hydro-Electric Power Commission



## Experience

For nearly 50 years, Vinylex Corporation has manufactured superior profile extrusions. A long-time leader in "value-added" extrusions, Vinylex takes pride in using only the finest raw materials for their products. We know that scrap, reclaimed, or recycled polymer will not meet our customers expectations. Consequently, only virgin resins are used in Vinylex Waterstop, never reprocessed materials.

## Technical and Sales Assistance

With customer satisfaction as our ultimate goal, we focus on maintaining consistently high standards of quality in products and service to our customers. Our resources, knowledge, experience, design, production capabilities and our ability to innovate are all at your service. Complete technical information and literature are available from Vinylex authorized representatives. Application engineering and laboratory facilities are available upon request.

## Guarantee

Vinylex Corporation warrants that Vinylex Waterstop, when installed in accordance with the manufacturer's instructions, Form No.'s 6005, 6035, 6016, 6012, 6008, and 5942, for normal use intended:

1. Will be free of defects in material and workmanship;
2. Will not become brittle or crack due to normal exposure;

3. Will not undergo a significant change in Shore A hardness in normal water control applications when measured in accordance with ASTM Standard Tests;
4. Will resist normal abrasion and tear failures;
5. Will not fail under normal expansion and contraction in joints where the waterstop has been installed with proper configuration and joint design.

This warranty is in lieu of all other warranties expressed or implied. Vinylex's liability under this warranty shall be limited to the purchase price of the portion of Vinylex Waterstop which proves to Vinylex's satisfaction to be defective or otherwise fails to meet the warranty's terms as outlined above.

## Delivery and Distribution

Vinylex Waterstops are available throughout North America and various export outlets through regional marketing representatives, and stocked in over 120 U.S. cities by local building material distributors.

**MEMBERS OF AMERICAN SOCIETY OF CONCRETE CONSTRUCTION  
AND CONSTRUCTION SPECIFICATIONS INSTITUTE**

**VINYLEX'S QUALITY SYSTEM IS CERTIFIED TO ISO9001/QS-9000.**



**P.O. Box 7187 • Knoxville, TN 37921-0887 • Phone 800-624-4435 or (865) 690-2211  
Fax (865) 691-6273 • Email: constr@vinylex.com**