

A-55 Sure-Lock Tie, A-56 Sure-Lock Bracket and A-57 Sure-Lock Strongback Bracket

Dayton Superior Sure-Lock Forming System consists of the A-55 Sure-Lock Tie, A-56 Sure-Lock Bracket and the A-57 Sure-Lock Strongback Bracket. This system is an economical single waler forming method based on 2 x 4 lumber and 3/4" plywood.

The A-55 Sure-Lock Tie is manufactured with self-centering 1" x 1" plastic cones that provide a nominal 1" breakback. Other breakbacks and waterseal washers are available for the A-55 tie on special order.

The A-56 Sure-Lock Bracket is a sturdy bracket designed with a rotating arm that captures the loop of the A-55 tie and firmly secures the tie and wale to the form.

The A-57 Sure-Lock Strongback Bracket attaches to the back of the A-56 bracket and holds a 2 x 4 strongback firmly to the form.



A-55 Sure-Lock Tie

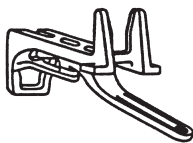

A-56 Sure-Lock Bracket

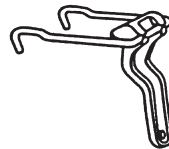

A-57 Sure-Lock Strong Back Clamp

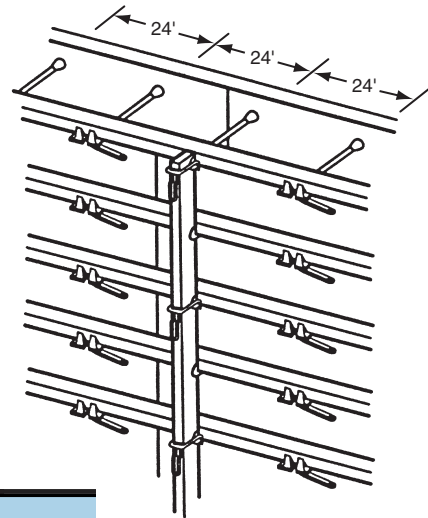

<p>To Order A-55 Sure-Lock Tie: Specify: (1) quantity, (2) name, (3) wall thickness, (4) special features desired.</p>	<p>Example: 5,000 pcs. A-55 Sure-Lock Ties, 10" wall with waterseal washers.</p>
<p>To Order A-56 Sure-Lock Bracket: Specify: (1) quantity, (2) name</p>	<p>Example: 500 pcs. A-56 Sure-Lock Brackets.</p>
<p>To Order A-57 Sure-Lock Strong Back Clamp: Specify: (1) quantity, (2) name.</p>	<p>Example: 200 pcs. A-57 Sure-Lock Strong Back Clamps.</p>

**2,250 lbs.
Safe Working Load**

SWL provides a factor of safety of approximately 2 to 1.

A-56-A Speedy Bracket and A-57-A Stiffback Bracket

Dayton Superior A-56-A Speedy Bracket is a simple one-piece bracket designed to accept the A-55 Sure-Lock Tie, above. The A-56-A bracket will accommodate single or double 2 x 4's; horizontally or vertically. Brackets are tempered for strength and rigidity and are designed so they can be utilized as its own breakback tool.

Dayton Superior A-57-A Stiffback Bracket attaches directly to the A-56-A Speedy Bracket and rigidly secures two 2 x 4 strongbacks in place to strengthen and align the formwork.

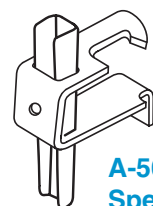

A-56-A Speedy Bracket

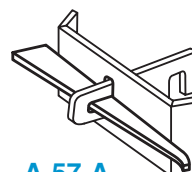
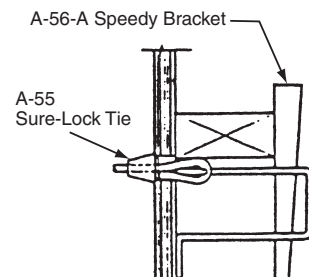

A-57-A Stiffback Bracket

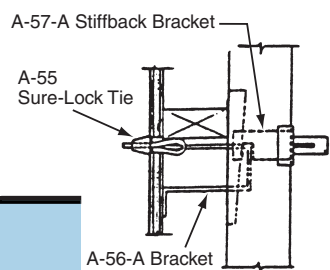

<p>To Order A-56-A: Specify: (1) quantity, (2) name.</p>	<p>Example: 500 pcs. A-56-A Speedy Bracket.</p>
<p>To Order A-57-A: Specify: (1) quantity, (2) name.</p>	<p>Example: 500 pcs. A-57-A Stiffback Bracket.</p>

**2,250 lbs.
Safe Working Load**

SWL provides a factor of safety of approximately 2 to 1.