

Movement Joint Products

Rapid® Control Joint Rubber Compound Rapid® Poly-Joint PVC Compound

DUR-O-WAL Control Joint is designed to control movement in concrete masonry. The 5/8 inch wide shear keys are designed to be vertically placed in sash grooves in the block. This allows the movement to be transferred from one side to the other and thus controlling cracking. All types are packaged 32 feet per carton. There are 12 pieces in each carton, each piece measures 32 inches. The Rubber product is black in color and the PVC is gray in color.

DA2001 Regular Rubber and DA2002 Regular PVC are recommended for use in all exterior wall applications using a backer rod and caulking to seal the joint. Control Joint is not a water stop.

DA2003, DA2004, DA2005 and DA2006 - the wide flange types are best used for interior wall applications and must be caulked to seal the joint. Control Joint is not a water stop.

Rubber Control Joint products are more flexible in colder temperatures and are impervious to oils and solvents.

Rapid® Control Joint Rubber

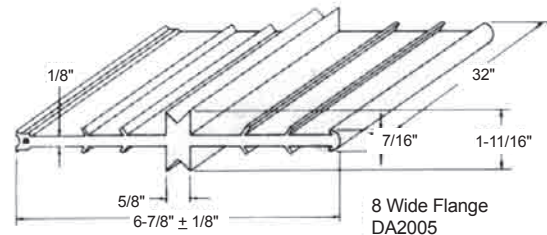
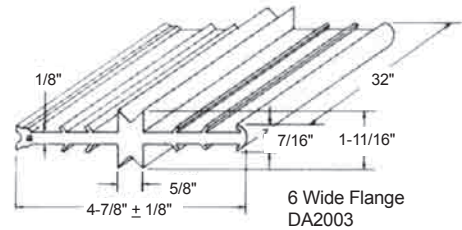
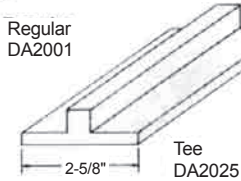
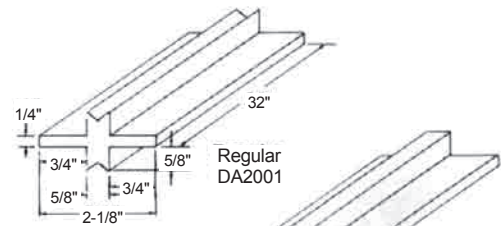

Material Specifications

Product	Specifications
Rapid Control Joint - Rubber	ASTM D2000 2AA-805
	ASTM D2240 Durometer Hardness
Rapid Poly - Joint - PVC	ASTM D2287 Type PVC 654-4
	ASTM D2240 Durometer Hardness

Shear Strength

Product	Average Load per 8" of Joint (lbs)	Shear Strength (psi)
Regular Rubber	2350	470
Wide Flange Rubber	2706	541
Regular PVC	2831	566
Wide Flange PVC	2283	490

Poly Joint PVC

DA2010 Rapid Soft Joint With Adhesive Backing

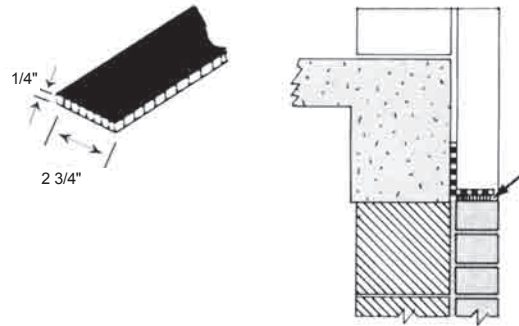
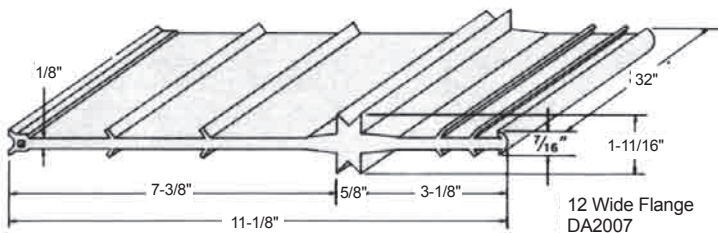
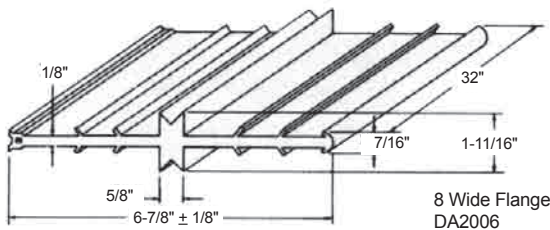
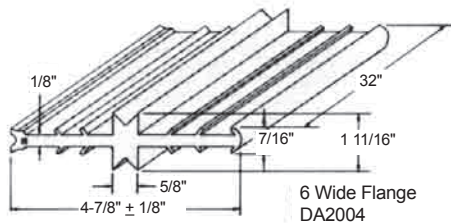
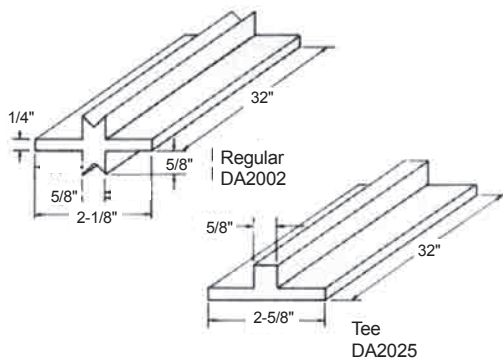

Product Description

DA2010 Rapid Soft Joint is designed to keep mortar and other debris outside of horizontal joints, generally under shelf angles, to allow for brick expansion. It has adhesive on one side with a release coated disposable backing paper. The closed cell neoprene rubber is provided in rolls of 50 feet. Standard size is 1/4" thick X 2-3/4" wide but other sizes are available subject to minimum orders.

DA2015 Rapid Expansion Joint

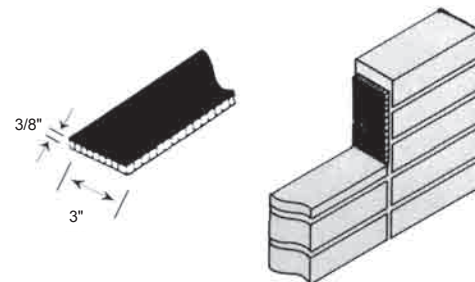

Product Description

DA2015 Rapid Expansion Joint is designed to keep mortar and other debris outside of vertical joints to allow for brick expansion. The closed cell neoprene rubber is provided in rolls of 50 feet. Standard size is 3/8" thick X 3" wide but other sizes are available subject to minimum orders.

Warranty

Seller makes no warranty of any kind, express or implied, except that the goods sold under this agreement shall be of the standard quality of seller, and buyer assumes all risk and liability resulting from the use of the goods, whether used singly or in combination with other goods. Seller neither assumes nor authorizes any person to assume for seller any other liability in connection with the sale or use of the goods sold, and there is no oral agreement or warranty collateral to or affecting this transaction.

Material Specifications

Product	Specification
DA2015 Rapid Expansion Joint	ASTM D1056,
and	Class RE-41
DA2010 Rapid Soft Joint	and 2A1

J10.60 10/05